

version .0

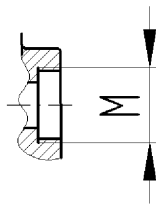
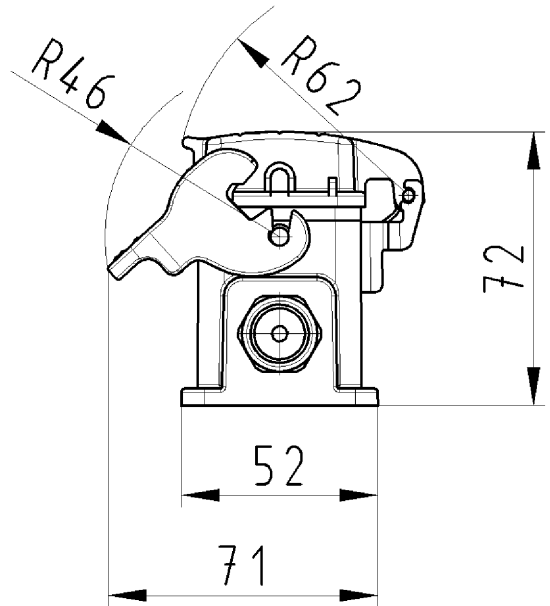
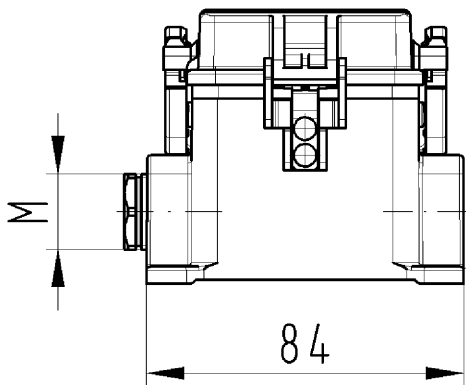

version .1

Gehäuseunterteil  
70.342.0635.0  
72.342.0635.0

Zeichnungsnummer  
70.342.0635.010W  
Gehäuseunterteil

19.11.2007  
Schreiber Patrick  
M 1:2